

BatteryProtect 12/24V

12/24V - 65A | 12/24V - 100A | 12/24V - 220A

rev 01 - 11/2022

This manual is also available in [HTML5](#).

Table of Contents

1. Introduction	1
2. Features	2
3. Installation and wiring examples	3
3.1. Precautions and installation notes	3
3.2. Warning when connecting inverters and inverters/chargers	4
3.3. Wiring examples	5
3.3.1. BatteryProtect in a simple system	5
3.3.2. BatteryProtect remote on/off switch	6
3.3.3. BatteryProtect in a lithium battery system with external BMS	6
3.3.4. BatteryProtect in a lithium system with external BMS and load disconnect output	7
3.3.5. Two BatteryProtects for load and charger control	8
3.3.6. BatteryProtect Alarm output wiring	8
4. Operation and programming	10
4.1. Operation modes	10
4.2. Programming	11
4.2.1. Programming via PROG pin to GND pin method	11
4.2.2. Programming table	12
4.3. Status indicator	12
4.4. Remote control and short circuit behavior	12
4.5. Error & Warning modes	12
5. Technical specifications	13
5.1. Technical specifications	13
6. Appendix	14
6.1. Error and Warning codes	14

1. Introduction

The BatteryProtect disconnects the battery from non-essential loads before it is completely discharged (which would damage the battery) or before it has insufficient power left to crank the engine.

It also provides an alternative to disable chargers without a remote on/off port to protect from over-voltage.

Compared to the Smart BatteryProtect, the BatteryProtect must be programmed via the PROG pin to GND pin method.

The BatteryProtect is a uni-directional device. It can only deal with current in one direction, so either current to a load, or current from a charger, but not both currents at the same time. In addition to this, current can only flow from the IN terminal to the OUT terminal.

2. Features

The BatteryProtect offers a wide range of different features. These include:

- Protection of the battery against excessive discharge and can be used as a system on/off switch.
- 12/24V auto ranging. The BatteryProtect automatically detects system voltage one time only (can be re-triggered - see section [Programming table \[12\]](#)).
- A special setting for Lithium batteries. This feature allows external control from a BMS like the VE.Bus BMS or Lynx Smart BMS. If the load disconnect output of a BMS is connected to the Remote H input and the signal becomes free-floating, the load is immediately disconnected.
- Ultra-low current consumption of 1.5mA: This is important in case of Li-ion batteries, especially after low voltage shutdown.
- Over voltage protection: To prevent damage to sensitive loads due to over voltage. The load is disconnected whenever the DC voltage exceeds 16.3V (for a 12V system) respectively 32.6V (for a 24V system).
- Ignition proof: No relays but MOSFET switches, and therefore no sparks.
- Delayed alarm output: The alarm output is activated if the battery voltage drops below the preset disconnect level for more than 12 seconds. Starting the engine will therefore not activate the alarm.
- Delayed load disconnect and delayed reconnect. Responding quickly within this delay, for example by reducing the load or starting a generator or charger to charge the batteries, can prevent loads from being switched off.

For a full description of all features, please see the [datasheets](#).

3. Installation and wiring examples

3.1. Precautions and installation notes

There are a few basic things to keep in mind when installing a BatteryProtect:

1. The BatteryProtect must be installed in a well-ventilated area and preferably close (max 50 cm) to the battery (but, due to possible corrosive gasses not above the battery!).
2. Choose the correct cable size and length to match the load. **Voltage drop over a long or undersized cable between the battery plus and the BP may result in a short circuit alarm when starting-up the load, or unexpected shutdown.** You can also find more information on selecting the right cable size and its protection in our book [Wiring Unlimited](#).
3. A properly sized fuse must be inserted according to local regulations in the cable between the battery and the BP.
4. Pay attention to the correct orientation. The BP is designed to allow current to flow from IN (battery) to OUT (load) terminals only. Reverse currents from OUT to IN terminals are strictly forbidden and will damage the device. If you wish to use the BP as a disconnection for a charge source, you must orient the unit in the system so that the current is flowing in the intended direction, IN to OUT.
5. The short circuit protection of the BP will be activated if you try to directly connect loads with capacitors, for example inverters or inverter/chargers, on their DC inputs. For that use case, please use the BP to control the remote on/off control on the inverter, instead of disconnecting the higher power DC line. **See also the warning on the next page.**
6. Use the supplied 1,5mm² wire for the GND connection, which should be connected directly to the battery negative terminal (or the chassis of a vehicle). No other equipment should be connected to this wire. Note that the GND cable **must** be protected accordingly. A 300mA fuse is sufficient.
7. The pin assignment of the connectors are printed either on the front or on the side of the housing.
8. The BP automatically detects the system voltage once only during initial power up. The selected voltage (12 or 24 V) is stored, and further automatic detection is disabled. See "d" in the programming table for how to reset it when re-using the BP in a different installation.
9. Do not connect the load output until the BP has been fully programmed.
10. A remote on/off switch can be connected between Remote H and Remote L. Alternatively, terminal H can be switched high (to battery positive), or terminal L can be switched low (to battery negative).
11. A buzzer, LED or relay can be connected between the alarm output terminal and the battery positive. Maximum load on the alarm output: 50mA (short circuit proof).

3.2. Warning when connecting inverters and inverters/chargers

⚠ Under no circumstances is it permitted to connect inverters or inverter/chargers to a BP via their DC inputs, a reverse current may flow that damages the BP. In case you want to control an inverter or inverter/charger via a BP, you must use the BP to control the inverter or inverter/charger via its remote port. See example below. Note that the image shown below is an example for all BatteryProtect models including the smart models.

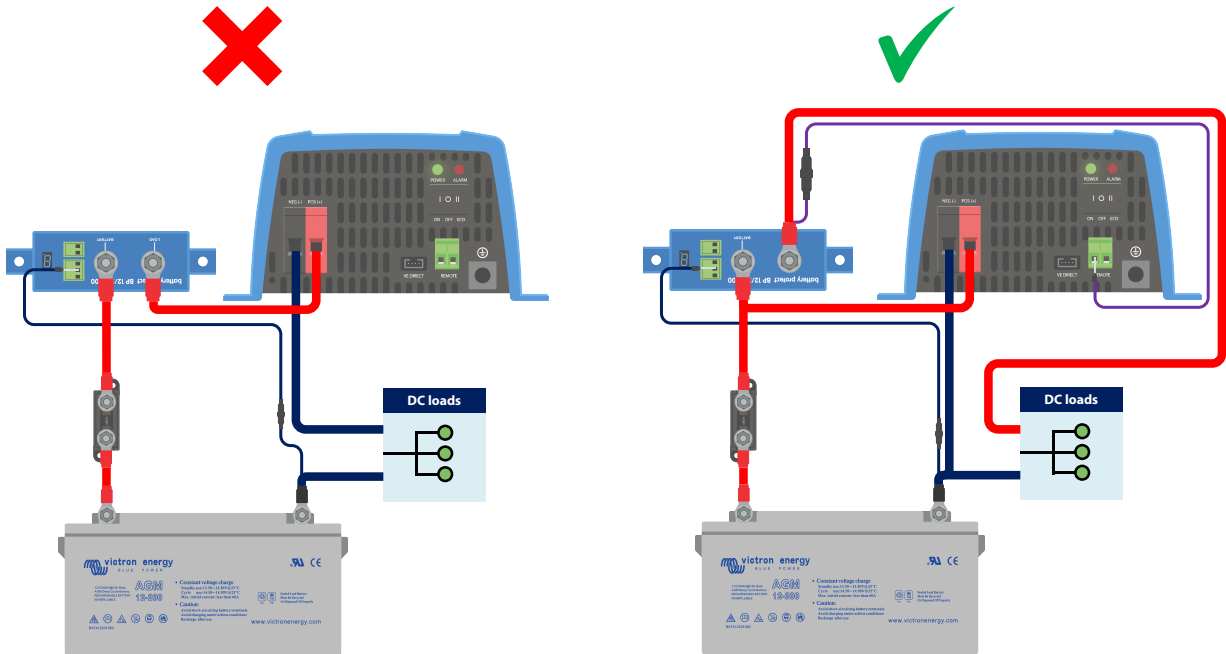

Left image: Inverter DC input connected via a BatteryProtect - **strictly forbidden**

Right image: Inverter controlled by its remote port via BatteryProtect

3.3. Wiring examples

This section contains various wiring examples to show all the possibilities of wiring.

3.3.1. BatteryProtect in a simple system

The example below shows a BatteryProtect with the wire loop (default) between L and H of the remote terminal. When the wire loop is removed, the BP disconnects the load after 90 seconds.

However, if the wire loop remains plugged in and the battery voltage drops below the programmed value for under voltage shutdown (see section [Programming \[11\]](#)), the BP disconnects the load after 90 seconds automatically.

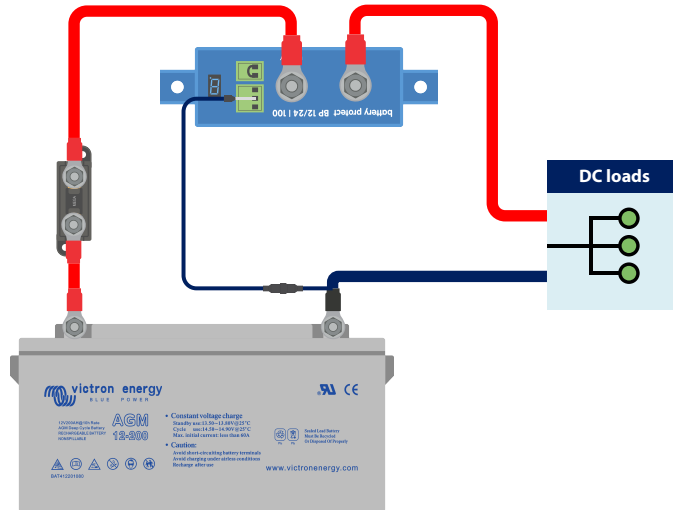

BatteryProtect in a simple system with wire loop between L and H input (factory default)

The same example below. This time the switch is wired between battery positive and the H input of the remote terminal.

When switched off, the H input becomes low. The load is disconnected after 90 seconds. When the switch is turned on again, the H input becomes high and the load is turned on with a delay of 30 seconds.

This works in the same way between battery minus and the L input of the remote terminal.

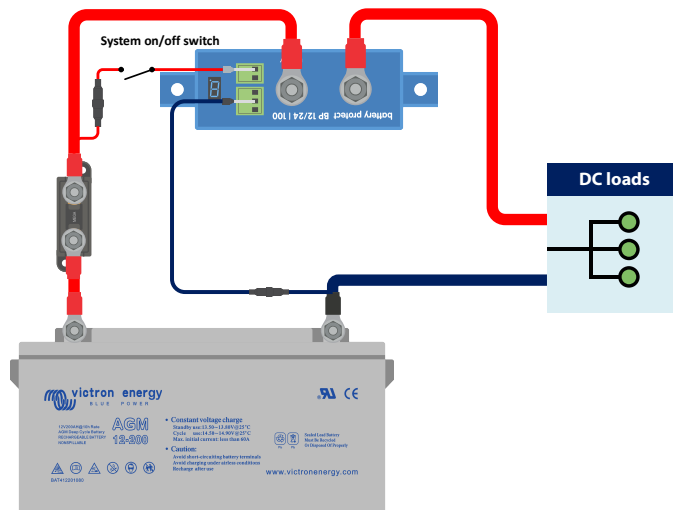

Switch wired between battery positive and H input of the remote terminal

3.3.2. BatteryProtect remote on/off switch

The below example shows a BatteryProtect in a simple system with a remote on/off switch wired to the remote terminals.

This switch can be used, for example, to turn the system remotely on and off. The power consumption of the BatteryProtect is negligible at less than 1mA when switched off (check the [Specifications chapter](#)).

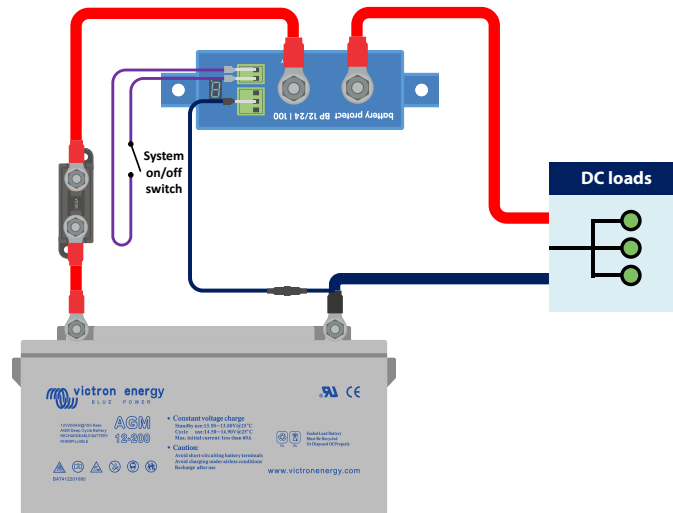

BatteryProtect with remote on/off switch

3.3.3. BatteryProtect in a lithium battery system with external BMS

The image below shows a BatteryProtect in a lithium battery system with external BMS. The external BMS ([Victron Lynx Smart BMS](#) in this example) has an ATD (allowed to discharge) and ATC (allowed to charge) output. Designed as a dry contact, ATD and ATC function as a switch that directly controls the BP via its remote terminal.

For this, the BatteryProtect must be programmed to Li-ion mode.

The dry contact is wired between the L and H connectors of the remote terminal.

If, for example, ATD opens in the event of a lithium battery cell undervoltage, the BP will immediately disconnect the load without delay.

The BP will remain disengaged for 30 seconds, even if ATD closes within this period. After this 30 seconds, it responds immediately and connects the load to the battery.

Please note that the under voltage thresholds and alarm output of the BP are inactive in this mode.

 If you have a lithium battery with internal BMS (so-called drop-ins) that does not have an output for controlling loads or chargers, the BP must be programmed in mode A or B. Mode C is not applicable in this case.

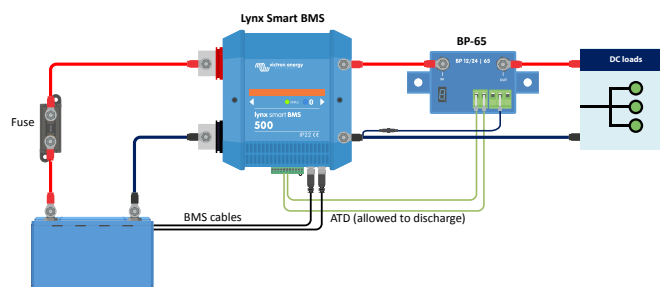

BatteryProtect in Li-ion mode controlled by ATD from a Lynx Smart BMS

3.3.4. BatteryProtect in a lithium system with external BMS and load disconnect output

This wiring example shows a BatteryProtect wired into a lithium system that is controlled by an external BMS ([Victron smallBMS with pre-alarm](#)). This BMS has a load and a charge disconnect output that can be wired directly to the BatteryProtect H input of the remote terminal.

As with the previous example, it is necessary to program the BP into Li-ion mode (see chapter [Programming \[11\]](#)).

If, for example, the smallBMS triggers the pre-alarm because of an imminent low cell voltage, the load output becomes free floating (normally high) when there is an actual low cell voltage and the BP will disconnect the load and remains off for 30 seconds, even if it receives a restart signal (H becomes high again) within this period. After this 30 seconds, it responds immediately to a restart signal.



If the system has been switched off due to low cell voltage, the BP will remain off for 30 seconds, even if it receives a restart signal within this period (which is most likely the case if no other loads are connected to the battery). After 3 attempts, the BP will remain off until the battery voltage has risen above 13V (or 26V for a 24V system) for at least 30 seconds (which is an indication that the battery is being recharged).

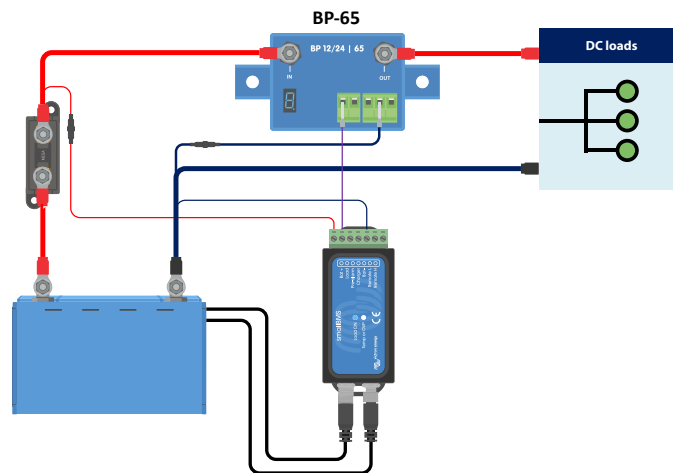

BatteryProtect uses the load disconnect of a smallBMS

3.3.5. Two BatteryProtects for load and charger control

It is also possible to have several BatteryProtect in one system, for example, to control chargers and loads at the same time.

If the BMS signals a cell undervoltage, the BP responsible for the load will disconnect the load from the battery to protect the battery from further discharge.

If the BMS signals a cell overvoltage or too low temperature to charge the lithium battery, the BP will disconnect the charger from the battery immediately.

Please also note the correct connection of the BPs: always follow the current flow from IN to OUT. The positive terminal of the charger goes to the IN input of the BP.

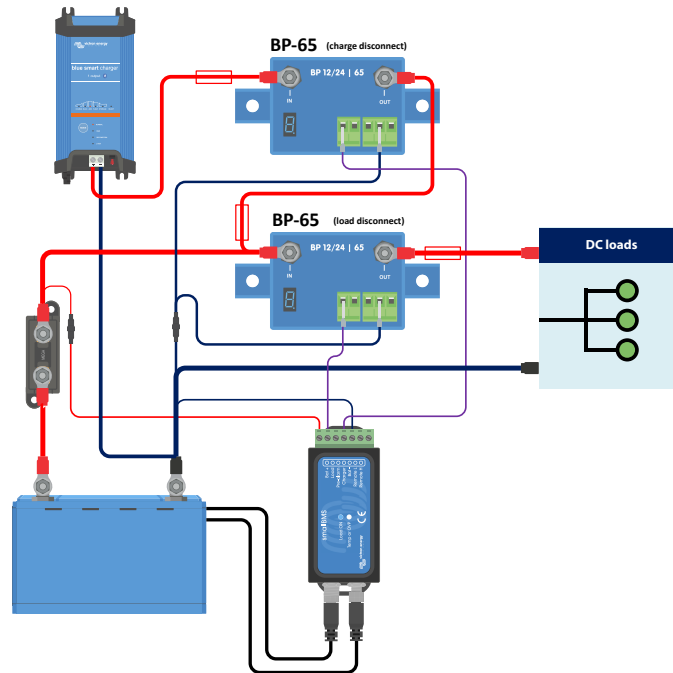

Two BatteryProtects take control of a charger and a load circuit

3.3.6. BatteryProtect Alarm output wiring

The alarm output can be wired e.g. to an LED, a buzzer or a relay. For this, the BatteryProtect must be programmed in the respective mode because of slight differences in the behavior. See also the section [Operation modes \[10\]](#) for more details.

Make sure that the LED, buzzer and relay match the system voltage.

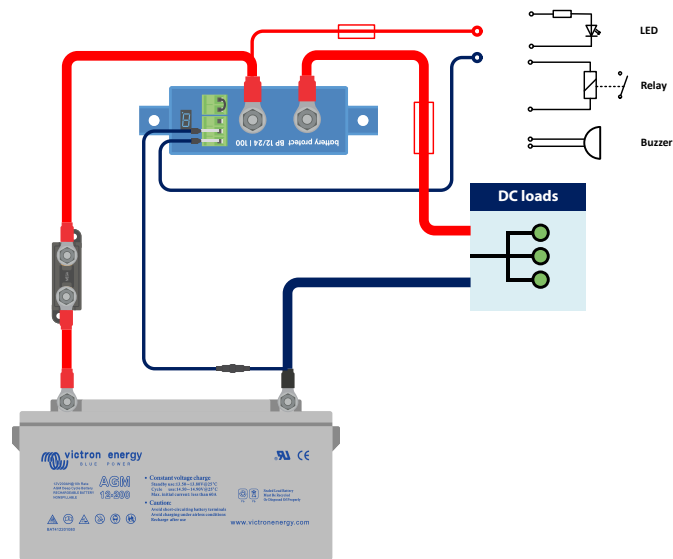

Wiring an LED, Buzzer or Relay to the BatteryProtect output

4. Operation and programming

4.1. Operation modes

The BatteryProtect has three operating modes, the appropriate mode can be selected via a programming procedure (see chapter [Programming \[11\]](#)).

- Mode A: Buzzer or LED mode (default).
- Mode B: Relay mode.
- Mode C: Li-ion mode.

Modes A and B affect the behavior of the alarm output.

Mode C, the Li-ion mode, takes into account lithium batteries that have an external BMS or a BMS with load and/or charge disconnect.

Buzzer or LED mode behaviour

- In case of under voltage, a continuous alarm will start after 12 seconds. The BP will disconnect the load after 90 seconds and the alarm will stop. Reconnect delay: 30 seconds.
- In case of over voltage, the load will be disconnected immediately and an intermittent alarm will remain on until the overvoltage problem has been corrected. There is no reconnect delay.

Relay mode behaviour

- In case of under voltage, the relay will engage after 12 seconds. The BP will disconnect the load after 90 seconds and the relay will disengage.
- In case of over voltage, the load will be disconnected immediately and the alarm output will remain inactive. Overvoltage trip levels: 16V (for a 12V system) respectively 32V (for a 24V system).

Li-ion mode behaviour

Only select the Li-Ion mode if your BMS has a load disconnect and/or a charge disconnect output. This is usually not the case for so-called drop-in batteries with internal BMS. For lithium batteries/BMS without load disconnect output, select mode A or B instead.

Connect the load or charge disconnect (depending on application) output of the BMS to the Remote H terminal of the BatteryProtect.

- The load or charger is disconnected **immediately** when the load or charge disconnect output of the BMS switches from 'high' to 'free floating'. The under voltage thresholds and alarm output of the BatteryProtect are inactive in this mode.
- It will remain disengaged for 30 seconds, even if it receives a re-engage signal within that time period. After 30 seconds it will respond immediately to a re-engage signal.

4.2. Programming

The BatteryProtect can be programmed by connecting the PROG pin to GND pin method.

4.2.1. Programming via PROG pin to GND pin method

Requirements prior to programming:

- The battery positive must be connected to the IN terminal. Do not connect the OUT terminal yet.
- The included ground wire must be connected to the battery minus and the GND terminal of the BatteryProtect 12/24V.
- The wire loop in the remote on/off terminal block must be removed.

Programming procedure:

1. Use a wire loop or a wired switch (preferably a push button) between the PROG pin and the GND pin.
2. While there is a connection between the PROG pin and the GND pin, the 7-segment display will first step through the shutdown and restart voltage combinations, as indicated by the numbers 0..9 (see the [Programming table \[12\]](#)).
3. Remove the wire loop or release the push button when the desired voltage mode is displayed.
4. The display will confirm the chosen voltage and default mode (A) twice.
5. Reconnect the wire loop or press the push button again, if a different operation mode (B, C or D) is required (see the [Programming table \[12\]](#)).
6. Disconnect the wire loop or release the push button when the required mode is displayed.
7. The display will confirm the chosen voltage and operation mode twice.

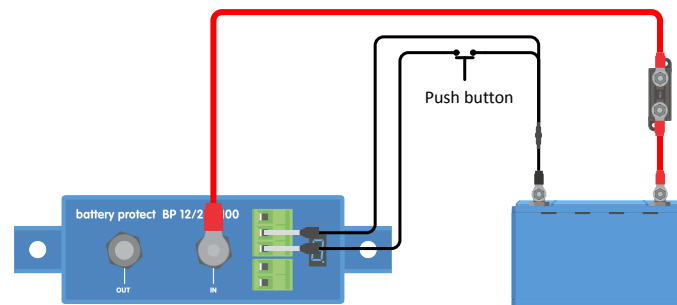

Push button wired to program the BatteryProtect

4.2.2. Programming table

Programming table for BatteryProtect 12/24V

7-segment display	Under voltage shutdown 12V/24V system	Under voltage restart 12V/24V system
0	10.5V/21.0V	12.0V/24.0V
1	10.0V/20.0V	11.5V/23.0V
2	9.5V/19.0V	11.5V/23.0V
3	11.25V/22.5V	13.25V/26.5V
4	11.5V/23.0V	13.8V/27.6V
5	10.5V/21.0V	12.8V/25.6V
6	11.5V/23.0V	12.8V/25.6V
7	11.8V/23.6V	12.8V/25.6V
8	12.0V/24.0V	13.0V/26.0V
9	10.0V/20.0V	13.2V/26.4V
A	Buzzer or LED mode	
b	Relay mode	
C	Lithium mode	
d	Detect system voltage	

4.3. Status indicator

The decimal point of the 7-segment display is used for status indication:

- Illuminated: the BatteryProtect is attempting to activate the output.
- Flash every 5 seconds: output is active.
- Flash every 2 seconds whilst in Li-ion mode: output 'connecting'. When in Li-ion mode the SBP will observe a dead period of 30 seconds after the remote input of the BP has become free floating.

4.4. Remote control and short circuit behavior

This section describes the behaviour of the BatteryProtect when it is controlled via the remote on/off input and when a short circuit has been detected.

- The BatteryProtect will connect the load 1 second after the remote input is closed.
- The BatteryProtect will disconnect the load immediately when the remote input is opened.
- When in Li-ion mode the BP will connect the load 30 seconds after the remote input of the BP has been pulled high by the BMS. This delay increases to 3 minutes in case of frequent switching.
- In case of a short circuit, the BatteryProtect will attempt to connect the load every 5 seconds. After two attempts the display will show E1 (short circuit detected).

4.5. Error & Warning modes

There are 4 possible error modes, indicated by the 7-segment display:

- E1 Short circuit
- E2 Over temperature / P2 Over temperature warning
- E3 Under voltage / P3 Under voltage warning
- E4 Over voltage

After 5 minutes the error is no longer displayed to reduce current consumption.

Please refer to the appendix chapter [Error and Warning codes \[14\]](#) for more info on each error.

5. Technical specifications

5.1. Technical specifications

BatteryProtect	BP-65	BP-100	BP-220
Max. continuous load current	65A	100A	220A
Peak current	250A	600A	600A
Operating voltage range	6 - 35 V		
Current consumption	When on: 1.5mA When off or low voltage shutdown: 0.6mA		
Alarm output delay	12 seconds		
Max. load on alarm output	50mA - short circuit proof		
Load disconnect delay	90 seconds (immediate if triggered by a BMS)		
Load reconnect delay	30 seconds		
Default thresholds	Disengage: 10.5 V or 21 V Engage: 12 V or 24 V		
Operating temperature range	Full load: -40 °C to +40 °C (up to 60% of nominal load at 50 °C)		
Connection	M6	M8	M8
Mounting Torque	5 Nm	9 Nm	9 Nm
Weight	0.2 kg 0.5 lbs	0.5 kg 1.1 lbs	0.8 kg 1.8 lbs
Dimensions (hwxwd)	40 x 48 x 106 mm	59 x 42 x 115 mm	62 x 123 x 120 mm
	1.6 x 1.9 x 4.2 inch	2.4 x 1.7 x 4.6 inch	2.5 x 4.9 x 4.8 inch

6. Appendix

6.1. Error and Warning codes

This appendix gives a list of error and warning codes and possible solutions.

E1: Short circuit

Short circuit protection is activated in the event of a short circuit, an overload condition or excessive inrush current - such as when attempting to directly power an inverter or inverter/charger.

1. Check for a potential short circuit condition.
2. Confirm that the load current draw does not exceed the BP current rating.
3. Use the BP to control the remote on/off switch on loads with high inrush currents, rather than directly powering/disconnecting the DC supply.
4. Check for loose/high resistance connections and ensure that appropriate gauge wiring is used in the installation.

E2: Over temperature

Over temperature protection is activated in the event of excessive internal temperature.

1. Confirm that the load current draw does not exceed the BP current rating.
2. Check for loose/high resistance connections and ensure that appropriate gauge wiring is used in the installation.
3. Do not install the BP unit in a location exposed to high temperature or radiant heat - relocate BP to a cooler position or provide additional active cooling.

E3: Under voltage

Under voltage protection is activated in the event that the input voltage drops below the under voltage limit selected for 90 seconds.

1. Switch off/disconnect loads and recharge the battery.
2. Check charging system and battery for proper operation.

E4: Over voltage

Over voltage protection is activated in the event that the input voltage exceeds 16V (for 12V systems) or 32V (for 24V systems).

1. Confirm the configuration of all charging devices in the system - particularly system voltage and charge voltage settings.
2. Check charging system for proper operation.
3. Confirm BP system voltage configuration is correct.